

5 Tn.

| MODELO | REF. | | | H. min. | | |
|---------|--------|-----------|-----------|---------|--------------------|-----|
| C - 450 | 13.351 | 5.000 Kg. | 1.300 Kg. | 130 mm. | 400/230 v. · 3 Kw. | 40" |
| C - 455 | 13.352 | 5.000 Kg. | 1.600 Kg. | 170 mm. | 400/230 v. · 3 Kw. | 40" |

TURISMOS + GRANDES FURGONES pasarela de 5.200 m/m.



PASARELAS EXTRA REFORZADAS

Vigas **doble T** refuerzan nuestras pasarelas, garantizando su perfecta **nivelación con el paso del tiempo**.



ALERTAS

Un **testigo** previene, en caso de incorrecta nivelación de las pasarelas, lo cual permite al cilindro trabajar en **buenas condiciones** y **alargar su vida útil**.

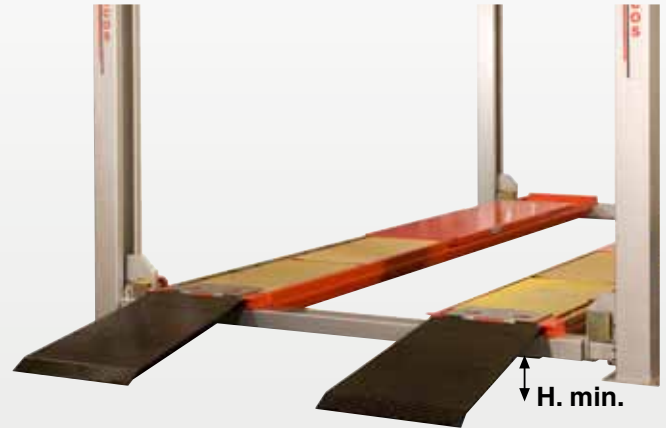

ALTURA MÍNIMA

La **más baja** del mercado, permitiendo trabajar con **rampas más cortas** para vehículos deportivos y de perfil bajo. C450, h min: 130mm C455, h min 170mm



SEGURIDAD x2

Cascos **prioriza** ante todo **la seguridad** incluyendo de serie **doble sistema de seguridad**, **mecánica** (barra de seguridad) y **neumática** (cremallera).

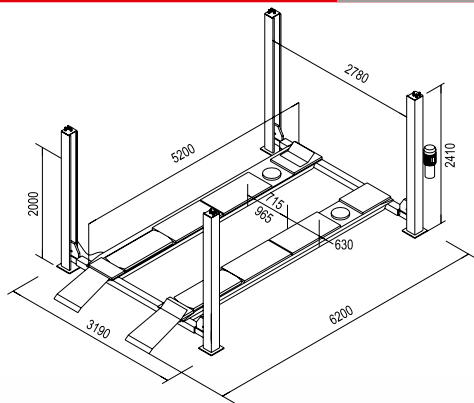

1 C - 450
REF.: 13.351

2 C - 455
REF.: 13.352

1 Pasarela lisa.

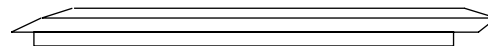

2 Pasarela de Alineación, con encastre delantero y platos de alinear traseros.

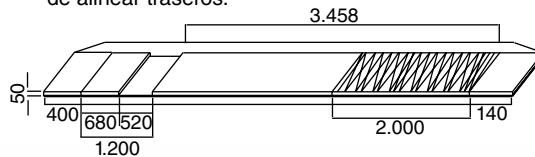

GATOS NEUMÁTICOS

| | TV 1500 | TV 3000 | DSTV 1500 | DSTV 3000 | DSTV 3000 AUDI |
|------|-----------|---------|-----------|-----------|----------------|
| REF. | 60.150 N. | 60.300 | 70.155 | 75.300 | 75.314 |
| | 1.500 | 3.000 | 1.500 | 3.000 | 3.000 |



TV 1.500



TV 3.000



DSTV 1.500

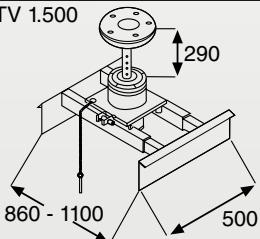

TV 1.500

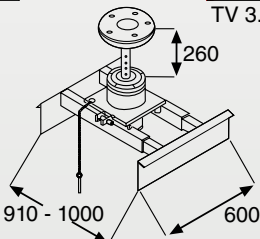

TV 3.000

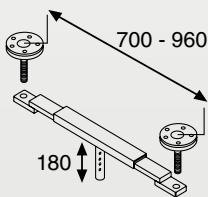

TV 1.500

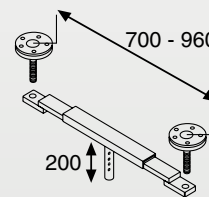

TV 3.000

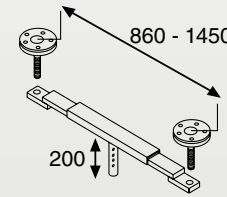

TV 3.000

GATOS OLEONEUMÁTICOS

780 - 1610 (mod. 2 tns)/780 - 1180 (mod. 2,6 tns.)

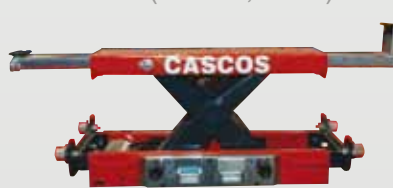
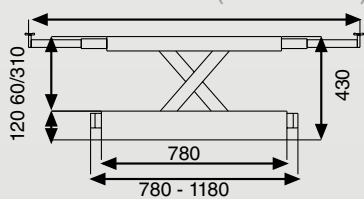

PASARELA SIN PESTAÑA

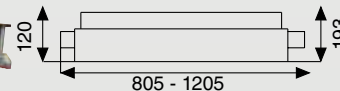

| | |
|---------|-------|
| 2 Tn. | 50515 |
| 2,6 Tn. | 50517 |

PASARELA CON PESTAÑA

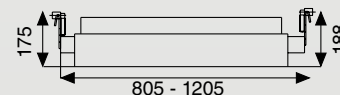

| | |
|---------|-------|
| 2 Tn. | 50514 |
| 2,6 Tn. | 50516 |

OPCIONAL



KIT DE ILUMINACIÓN 24 v. Ref. 34051



KIT DE ENERGÍA Ref. 26150

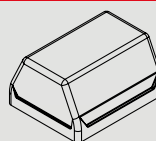

| CAPERUZA | REF. |
|------------------------------|--------|
| C - 440/41/42/43/44/45/50/55 | 32.129 |

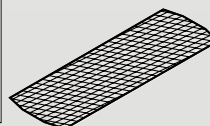

| PLATOS MÓVILES | REF. |
|----------------|--------|
| C - 432 | 29.700 |
| C - 442 | 33.700 |



CASCOS MAQUINARIA, S.A

Zurrupitieta, 8 - Pol. Ind. Júndiz • Apartado 264
01015 VITORIA-GASTEIZ España - Spain

Tel. +34 945 290 294 - Fax +34 945 290 055
e-mail: cascos@cascos.es • www.cascos.es

CASCOS MAQUINARIA SE RESERVA EL DERECHO DE REALIZAR MODIFICACIONES TECNICAS SIN PREVIO AVISO

